

产品BOM表

NO.	产品名称	产品编码	数量	材质/表面处理
①	GL-P1313H前盖-PBT白	99.02.73.200-Q1	1	PBT+15%GF/素材白
②	GL-P1313H后盖-PBT白	99.02.73.200-H2	1	
③	COB免焊支架端子		2	t=0.25mm铜镀镍+加硬

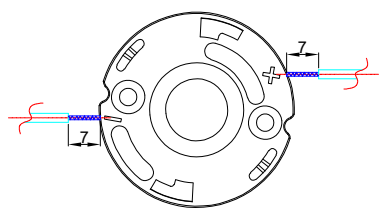
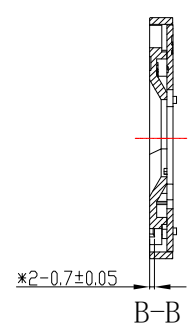
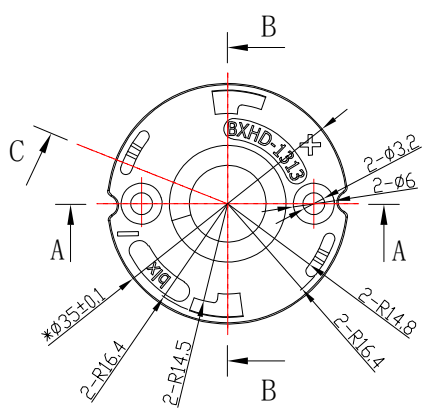
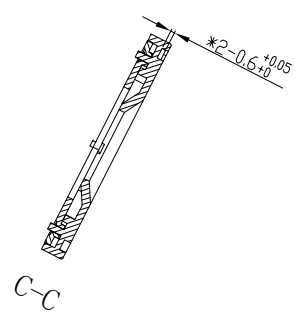
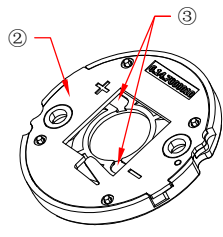
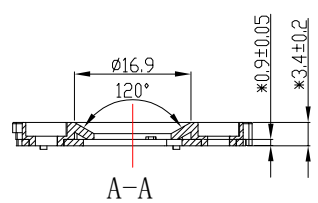
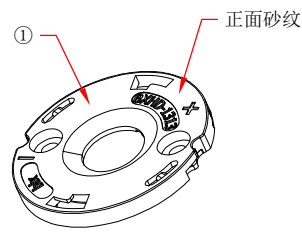
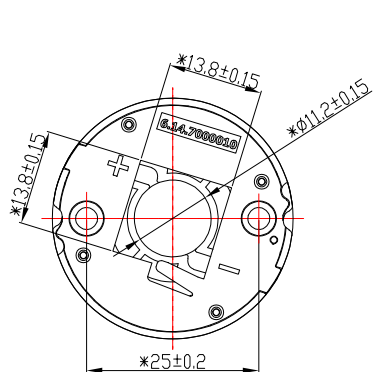

Wire specifications:
0.32 mm² to 0.81 mm².
18AWG, 20AWG, 22AWG.
Strip length: 7 mm. Surface tin-plated.

电线规格:
0.32毫米²至0.81毫米².
18AWG, 20AWG, 22AWG.
剥线长度7毫米, 表面镀锡。

技术要求:
1.材质: 详见bom表。
Material: Refer to the BOM table.
2. "*" 标记为重点控制尺寸。
The "*" marked items are the key controlled dimensions.
3.未注公差按GB/T14486-2008-MT6。
The unmarked tolerances follow GB/T14486-2008-MT6.
4.适配: V13, CLU 03X等基板规格为19×19的COB光源。
Compatibility: V13, CLU 03X and other substrate specifications with a size of 19×19 for COB light sources

				Nata [®]		版本 VERSIONS	
						K0-PL	
				产品编码 PRODUCT CODE		99.02.73.200	
				产品名称 PRODUCT NAME		COB1313H-L9光源免焊支架 2线-PBT白Ø35H3.5	
				客户 CUSTOMER		NT	
				单位 UNIT		客户产品编号 CUSTOMER PRODUCT CODE	
				mm		GL-P1313H-2线	
标记 MARK	处数 NO. OF MODIF.	更改内容 MODIFICATIONS		签名 SIGNED BY	更改日期 MODIF. DATE		
设计 DESIGNER		制图 DRAWN BY		比例 SCALE	1:1		
工艺 TECHNICIAN		审核 CHECKED BY		视角 1st ANGLE PROJECTION			
批准 APPROVED BY	日期 DATE (DD-MM-YYYY)	05-11-2025		页数 PAGE	SHEET 1 OF 1	产品图 PRODUCT DRAWING	